

**BUXKIN<sup>®</sup>**

# **BUXKIN** original

Installation Guide



## TABLE OF CONTENTS

01 PREPARATION	3
02 CUTTING ROLLS	4
03 RIB ALIGNMENT	5
04 DETAILING	6
05 BONDING	9
06 AFTERCARE	10

### Disclaimer

In this document we share our experience from 6,000+ sqm of installations, and what has worked for us. We are always learning, and will update this document. Every project and site is unique - it is up to the installer to test these methods and be comfortable they are suitable for their unique project.

## BEFORE INSTALLING

### 01. Handling and storage

The average length of a roll is 6 linear meters and weighs 20-35kg depending on the material. Rolls may have multiple lengths taped together. **Due to their size, rolls should be handled by two people.**

It is important to either stand the rolls on their ends, or lay them on a flat surface. Laying the rolls on bearers or stacking the rolls will damage the ribs.

### 02. Order verification

Rolls should be unwrapped from their original packaging and inspected to verify that you have the correct rib size and colour.

### 03. Acclimatisation

The material can change dimensionally by up to 0.5% from cold damp conditions (international freight during winter) to warm dry conditions (commercial offices with air conditioning). The material should be acclimatised for 24 to 72 hours, unwrapped and in its finished environment, before cutting it to size. The greater the change in environmental conditions, the longer the acclimatisation period.

**This will minimise shrinkage. Leather is affected more than felt.**

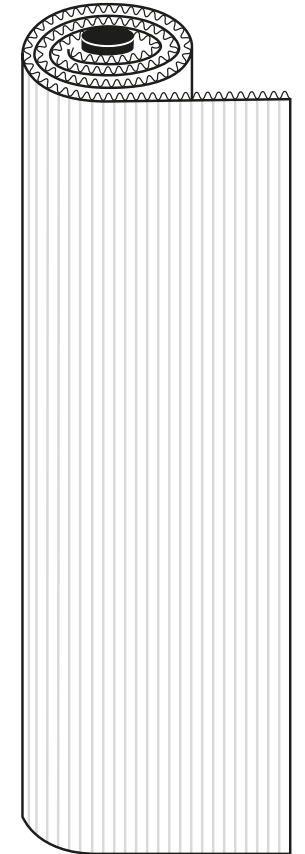

Ribs run across the rolls.

**Rolls are supplied approx 25mm (1") oversize and require trimming on the edges.**

- 1.45m (57") for leather
- 1.80m (70") for wool felt
- 2.00m (78") for synthetic felt

The roll length is to the customer's requirements, with a maximum roll length of approximately 6 linear meters (20' LF).

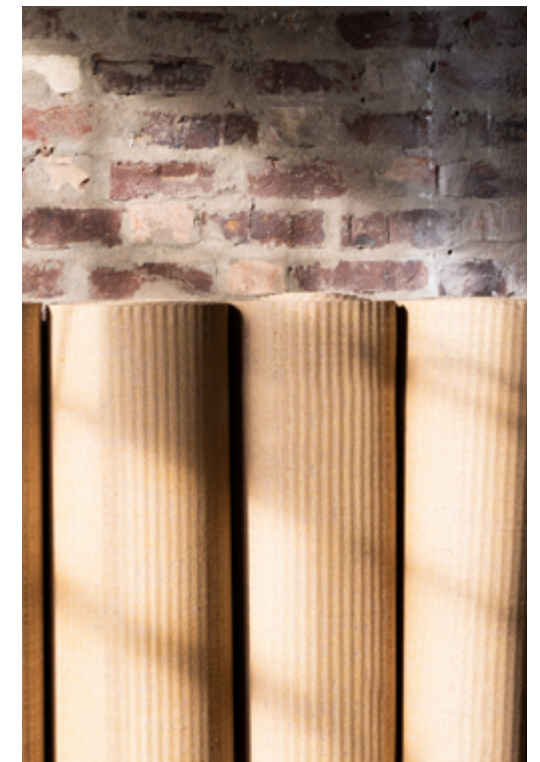



# 01 INSTALLATION PREPARATION

## 01. Wall preparation

Wall surface should be clean, dry and smooth. They should be properly primed and sealed. The panels can be installed directly on the wall or MDF panels.

## 02. Panel matching

Due to the recycled nature of the material, shade differences may occur, so it is important to check the panels when matching a pair.

## 03. Rib orientation

Depending on which way you hold the panel, all rib sizes may lean to the left or right, so it is important to lean the material the same way. Please see the pictures below. With the small rib size, this may be less noticeable, but when you join two panels together, it is easier to check that the ribs run in the same direction.

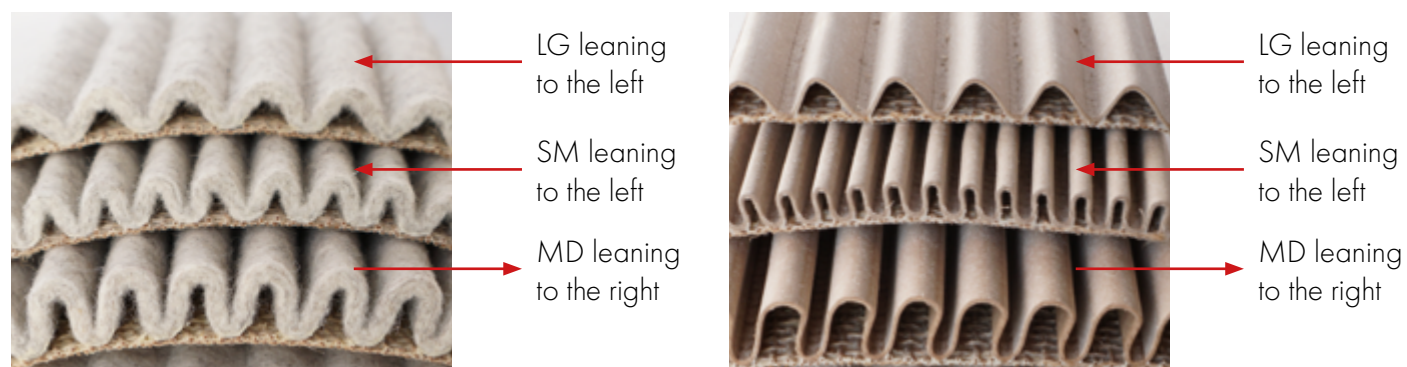

## 04. Tools and consumables

Recommended tools that have proven to work very well for various types of installation.

- Stanley knife with straight blade
- Stanley knife with hooked blade
- 25mm snap-off utility knife
- Track plunge saw with fine blade and guide rail
- 18 gauge brad nailer
- Sharpies (varied colour set - to colour nail heads)
- Drop sheets, floor protection (when spraying glue)
- Lond wand spray gun with 6501 tip and canister trolley
- Sharp knife and blades

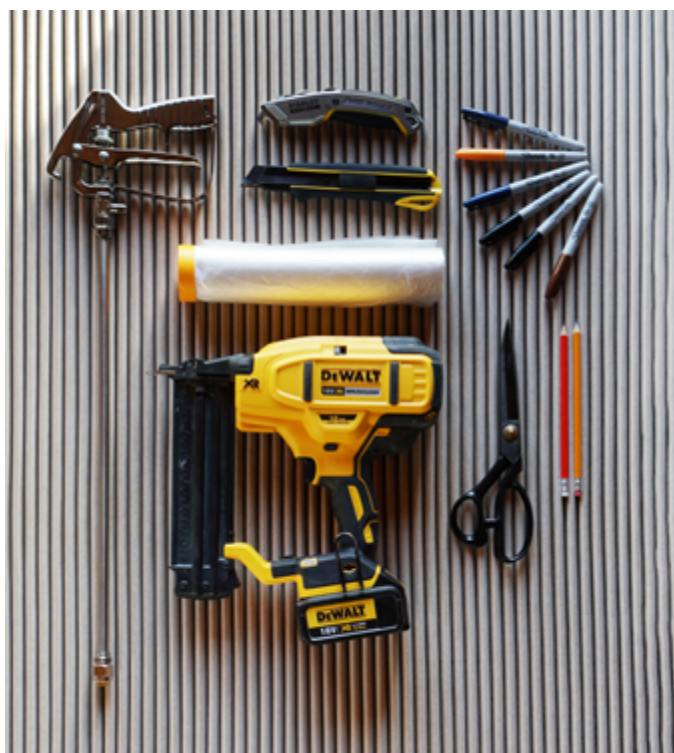

# 02 CUTTING ROLLS

## Cutting to length: Parallel to the ribs

The material should only be cut **between the ribs**, and lengths under 2.4m are more practical to trim and install. A thin aluminum angle makes a good straight edge and guides the knife at the bottom of the rib. The material can only be cut to the nearest whole rib.

If you need to align the ribs between two panels you must ensure they have the same number of ribs before cutting. To fine-tune an exact length, follow the method for rib alignment overpage.

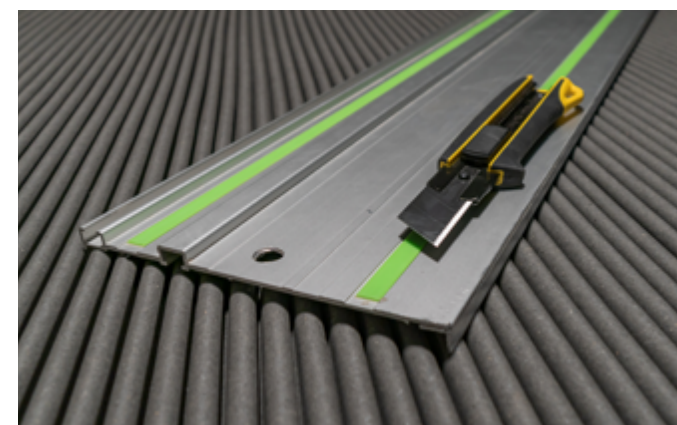
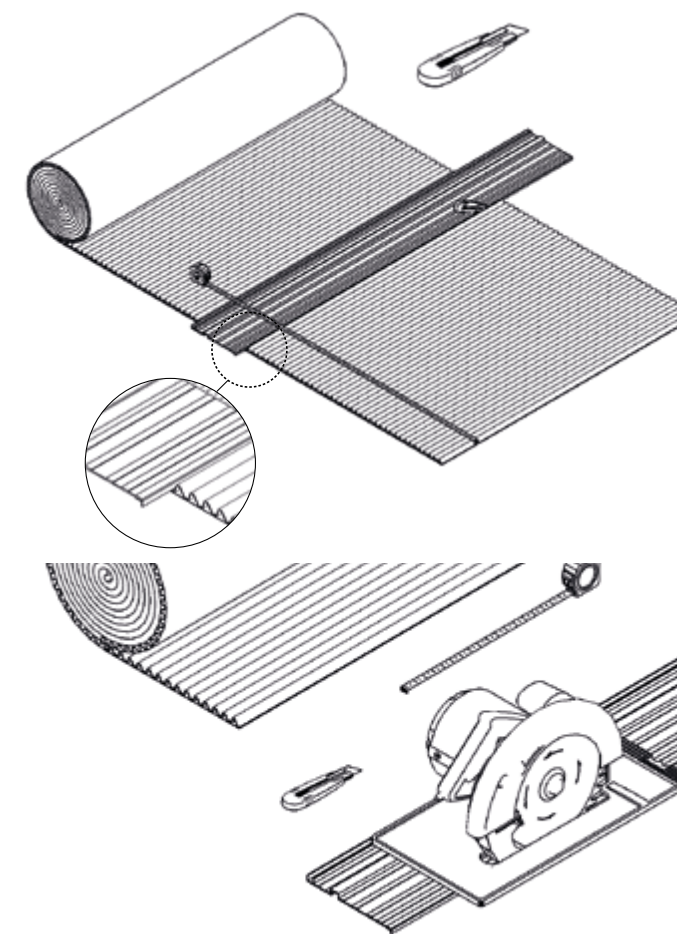

## Cutting to height: Across the ribs

All the materials can be cut with a straight edge and sharp knife. For repeat trims and cuts we recommend a track saw with a thin, fine-toothed blade. Push the saw slowly for the best finish. Felt cut by saw may require the edge to be trimmed with scissors. For clean edges we recommend using a KeenCut Material Cutter. Depending how it is viewed in your design - choose the most efficient method.

If the product has not been acclimatised (particularly the leather) allow up to 0.5% extra to account for shrinkage.

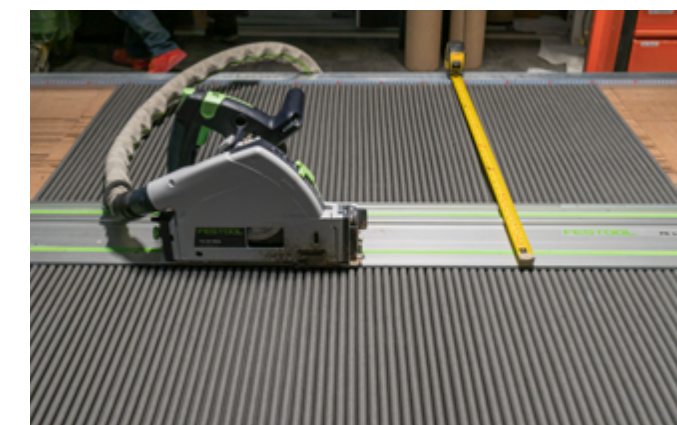
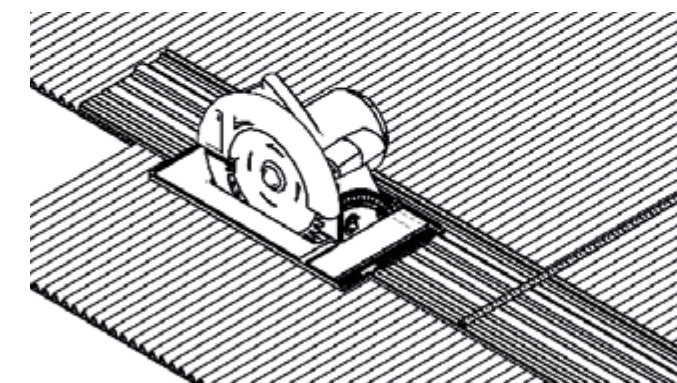
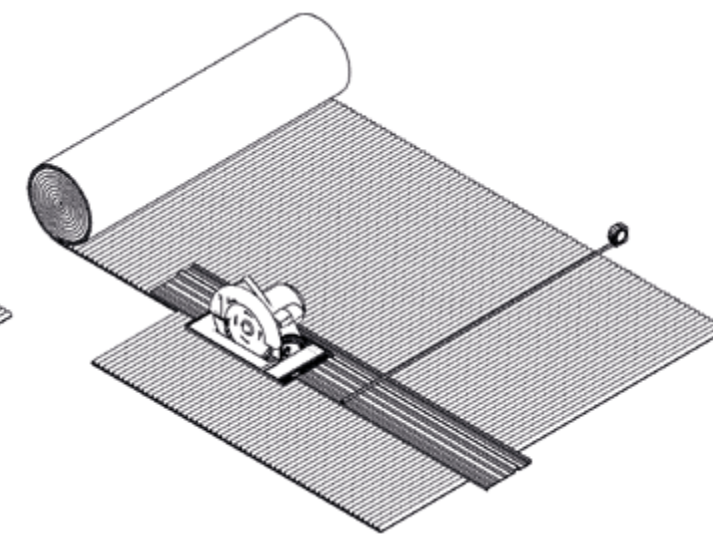



# 03 RIB ALIGNMENT

The ribs sizes have a tolerance of 2%, meaning rib alignment between panels cannot be assumed, but can be achieved. It's important that the panels have the same number of ribs. When considering rib alignment with T-trim or shadow gap, we recommend using **medium rib size** for leather or felt due to its flexibility of size.



**Step 1:** Use a hooked knife blade to carefully add a relief cut through the backing material only, this will allow a single rib to stretch.



**Step 2:** Add relief cuts at required intervals.

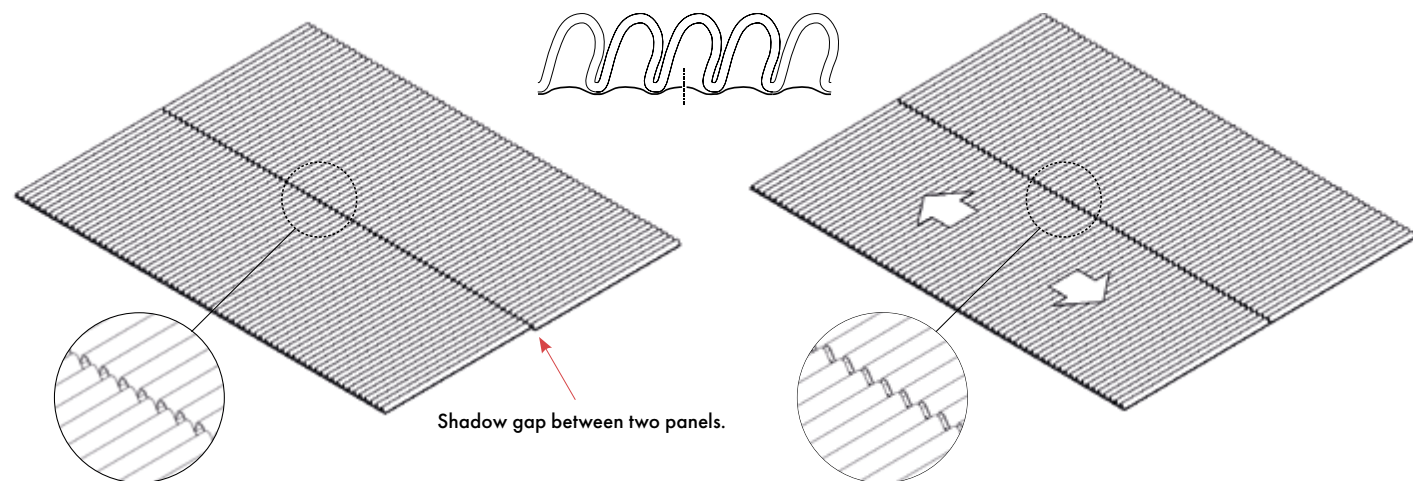

**Before:** Imperfect rib alignment.



**After:** Ribs aligned.

# 04 DETAILING

Junction and penetration details can enhance or detract from a design. They should be discussed, designed and agreed prior to installation. The materials are flexible and many solutions are possible.

Please note that we do not supply profiles and end stops. Your installation partner will be able to source these from a local vendor. If you require a corner profile or end stop, please let us know so that we can add some flat material to your order. We are happy to advise you on the most suitable solution for your project.

To see detailing solutions already executed, please visit our website at [BUXKIN - detailing](https://www.buxkin.com/detailing).

## Corners and junction details

The material works best with radius corners greater than 100mm diameter, but for sharp corners the level of traffic should be considered.

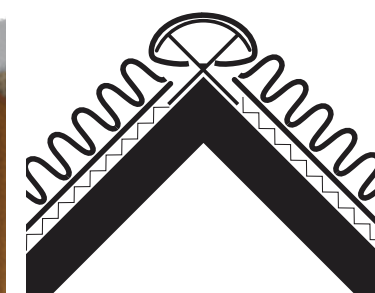
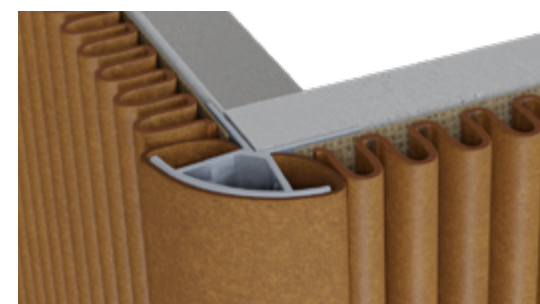

A corner profile can be wrapped in matching leather to create a more robust corner junction.

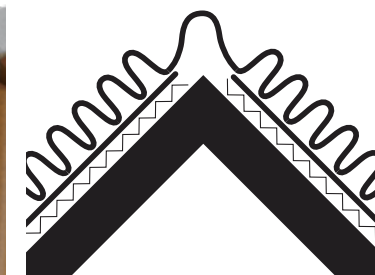
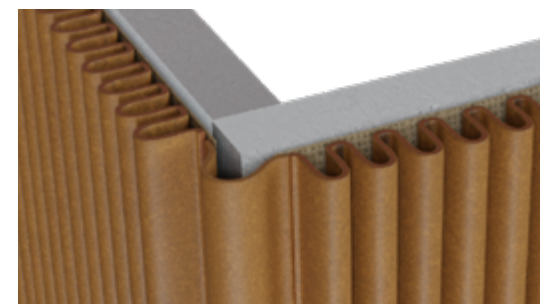

External corners are improved by the addition of a relief cut in the backing material.

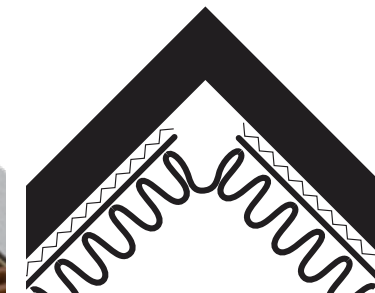
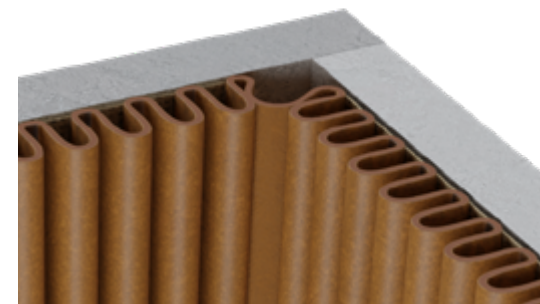

Internal corners are improved by putting a relief cut in the backing material.

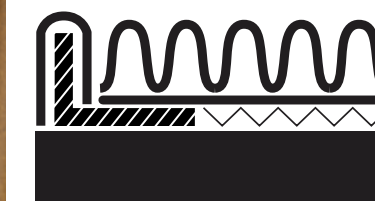

An end stop can be produced by the installer using flat leather to match the rib size and material choice.





Joins that run perpendicular to the rib direction should be expressed rather than butt jointed.  
 Joins that run parallel to the rib direction are invisible with careful cutting in the trough of adjacent ribs.

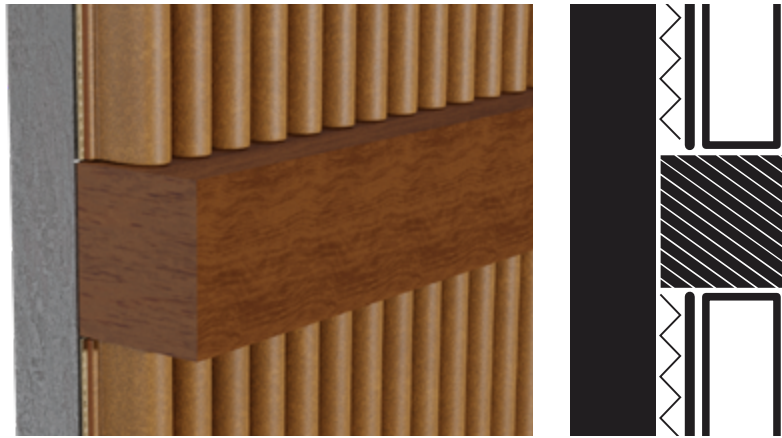

**A timber detail can reflect other timber finishes in the scheme to create a panel break or fixing location.**

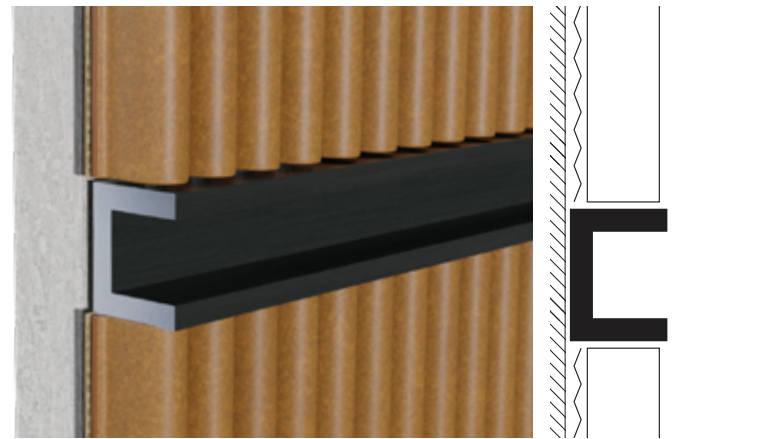

**An aluminium channel creates a shadow gap with clean termination for the ribbed material. Can be finished in any colour.**



**A metal profile can match other framing details within your concept.**

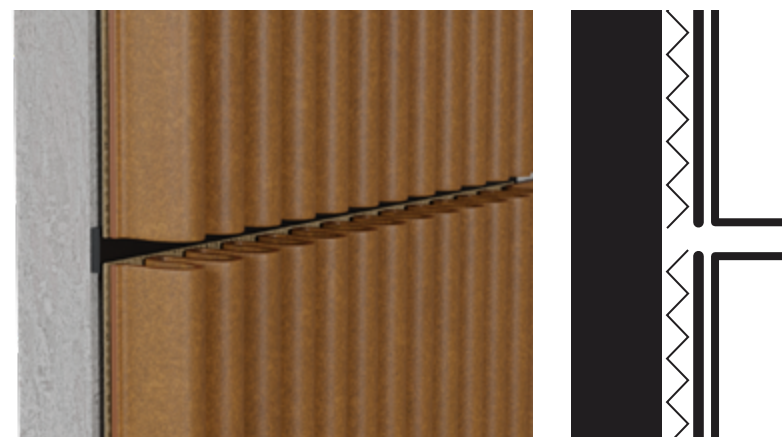

**A shadow gap of 3-10mm can be created depending on rib size. Paint the gap black before application if needed.**



### Joining panels

When joining the panels, it is important to make a clean cut between the ribs with a sharp blade. Place the rail with straight edge, or aluminium angle, close to one rib, so that the other rib is left with a piece of material attached - a tab. To get a good join, make sure you are butting together a piece of leather with a tab, and one which is cut close to the rib. This will avoid the gap between the ribs at the join looking too big or too small.

**NOTE:** This is easier to do with wool felt panels due to the more woolly form of the material.

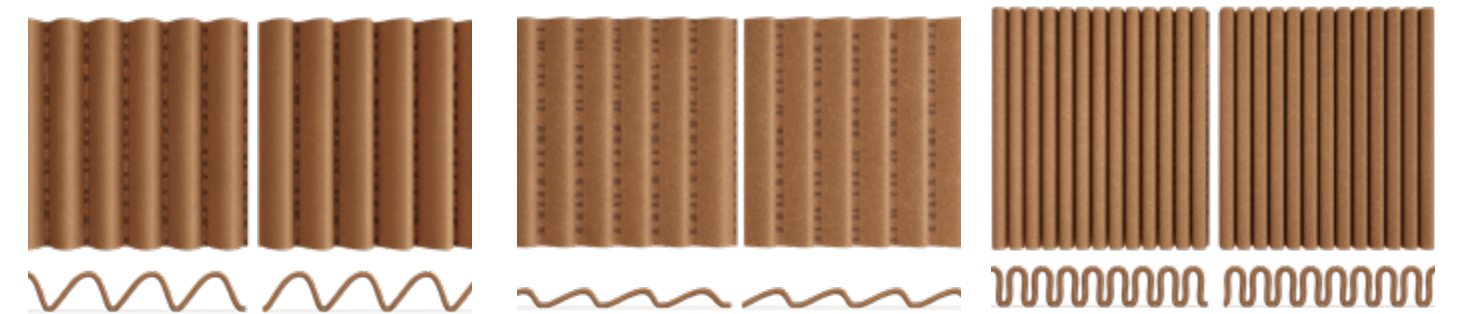
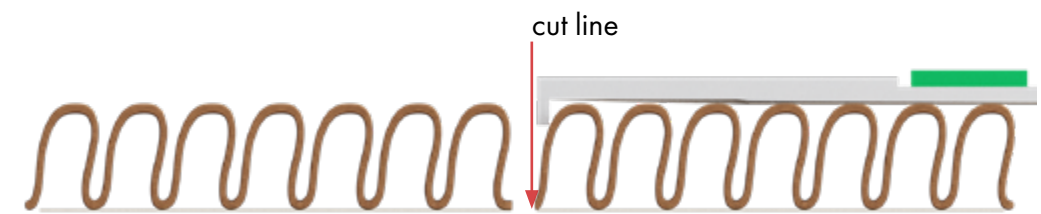



# 05 BONDING

Our preferred bonding method is spray contact adhesive. Where available, we recommend [Tensorgrip F31](#). Use all recommended protective equipment such as gloves, safety glasses and vapour respiratory protection, and carefully follow the adhesive manufacturer's instructions.

Prior to bonding, dry fit the material to check the size and then make adjustments as necessary after cutting the panels to size.

### Considerations:

- Area must be well ventilated and respiratory protection required.
- Important to follow manufacturers guidance on application and working times for the adhesive.

### Method

- Ensure surface is clean, dry, free of dust and sealed with a mist coat of paint if porous.
- Cut fabric to required size, and test fit before proceeding.
- Mask surrounding trims and sensitive surfaces with masking tape or masking film.
- Spray wall following manufacturer's guidance for coverage.
- Spray back of fabric, while laid flat on temporary floor protection and make sure the floor is **relatively clean**. You can also lean the material against a covered wall so you will not get the glue on the surroundings.
- Wait until both surfaces are touch dry then apply the fabric to the wall aligning one edge first and checking top and bottom edges as you unroll the fabric.
- Ensure the whole surface has been gently pressed into the wall, taking care not to damage or squash the ribs.
- This type of adhesive requires gentle pressure over the entire area of the panel.
- If needed, use a nail gun to add extra hold to the panels.
- When complete apply suitable protection for the area based on subsequent works.

IMPORTANT: Always ensure you wear your PPE, especially glasses, gloves and mask.

Please contact us at [info@buxkin.com](mailto:info@buxkin.com) if you have any questions.

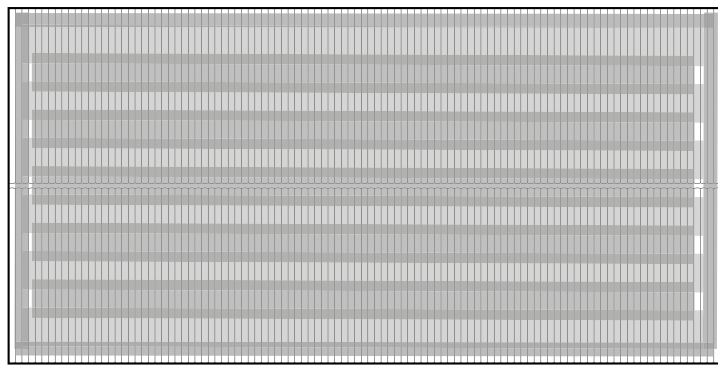

Above: Spraying method.

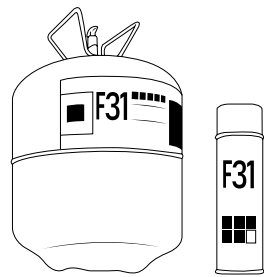

# 06 AFTERCARE

### Maintenance: Regular cleaning

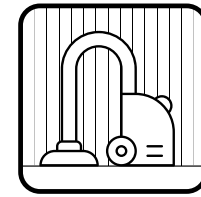

Gently vacuum using a soft brush attachment

- felt (all)
- leather (all)

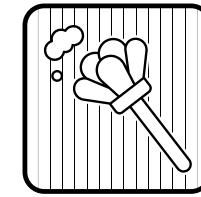

Gently clean with feather duster or clean, dry microfibre cloth

- felt (all)
- leather (all)

### Maintenance: Spot cleaning

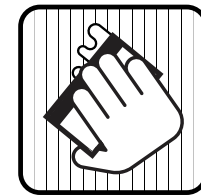

Gently sand the stain with 240 grit or higher sand-coloured sandpaper

- uncoated leather

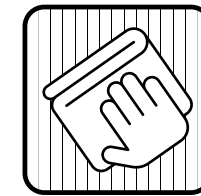

Blot up the liquid with dry cloth or paper towels

- felt (all)
- leather (all)

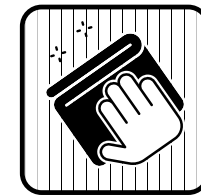

Use warm water or a mild dry-cleaning solvent

- felt (all)
- coated leather

**Uncoated leather** is vulnerable to stains and marks. General dust and debris can be removed with a duster or dry cloth. Light marks can be removed through light sanding with 240 grit or higher sandpaper, but it must not get wet as it will absorb the moisture and stain.

**Clear coated leather** is water resistant and resists marking. Dry dust and debris should be removed with a duster or dry cloth. A damp cloth with soap can be used on heavier marks but care must be taken not to wet any cut ends as this may stain behind the coating.

At the end of its life, the leather can be pulled away from the backing. The jute backing is biodegradable, and the leather can be recycled as leather again.

**All our felt products** are highly resistant to staining and marks. Vacuum occasionally with a brush fitting to remove air-borne debris. Should soiling occur, spot clean with mild soap and warm water. Avoid aggressive rubbing as this can change the surface appearance.

At the end of its life, the felt can be pulled away from the backing. The jute backing is biodegradable, and the felt can be recycled and felted again.

Revision date: 07/02/2024



**BUXKIN<sup>®</sup>**

Creative use of sustainable materials